

Harvard-MIT Division of Health Sciences and Technology
HST.535: Principles and Practice of Tissue Engineering
Instructor: Myron Spector

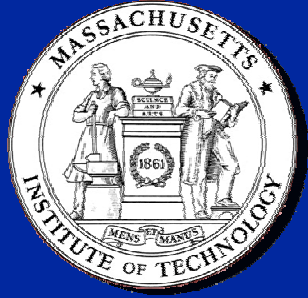

Massachusetts Institute of Technology
Harvard Medical School
Brigham and Women's Hospital
VA Boston Healthcare System

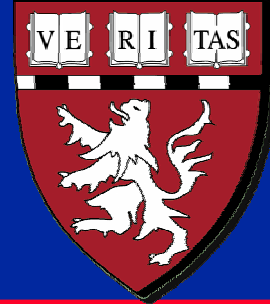

HST 535

CARTILAGE REPAIR

M. Spector, Ph.D.

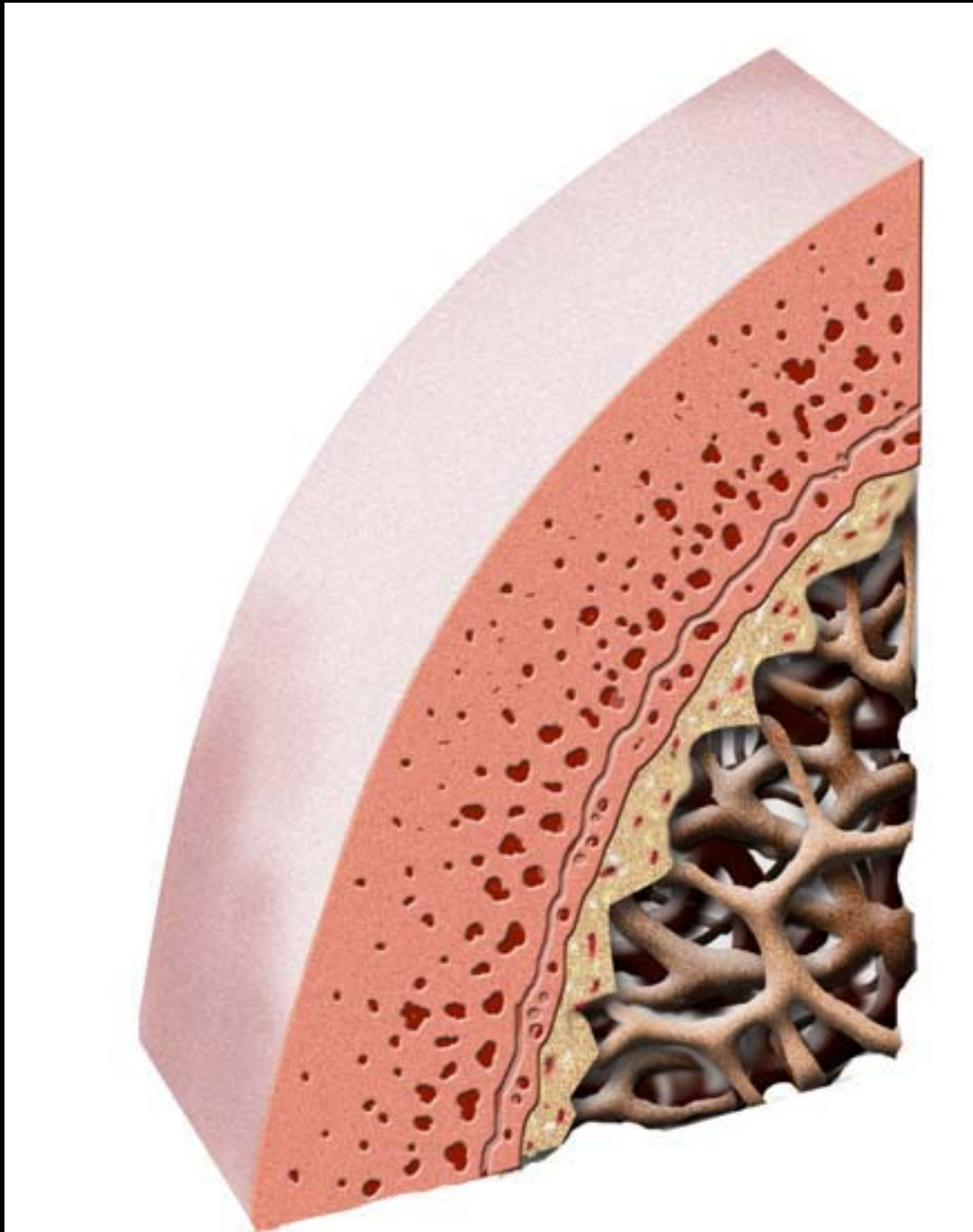

Figure by MIT OCW.

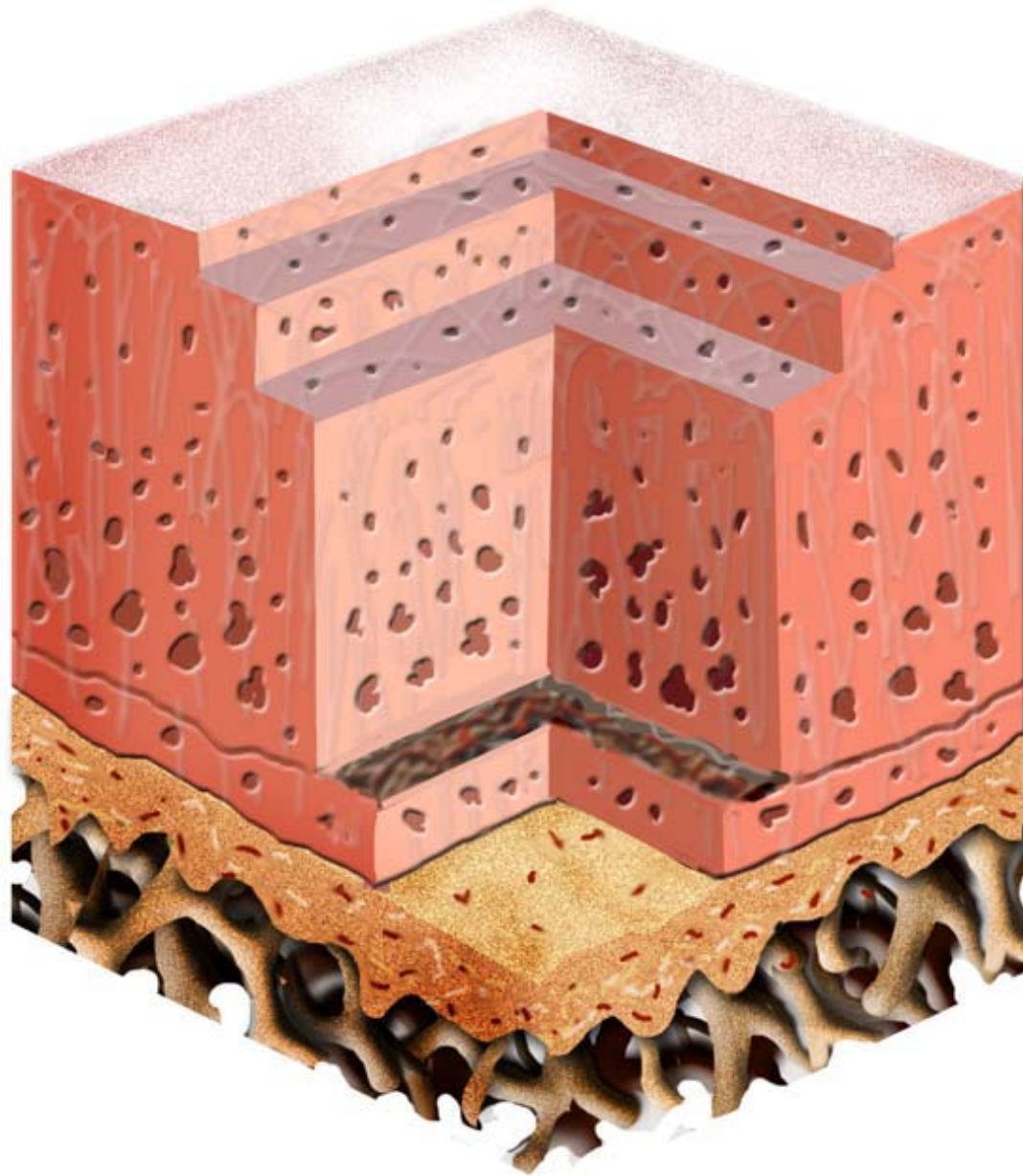

Figure by MIT OCW.

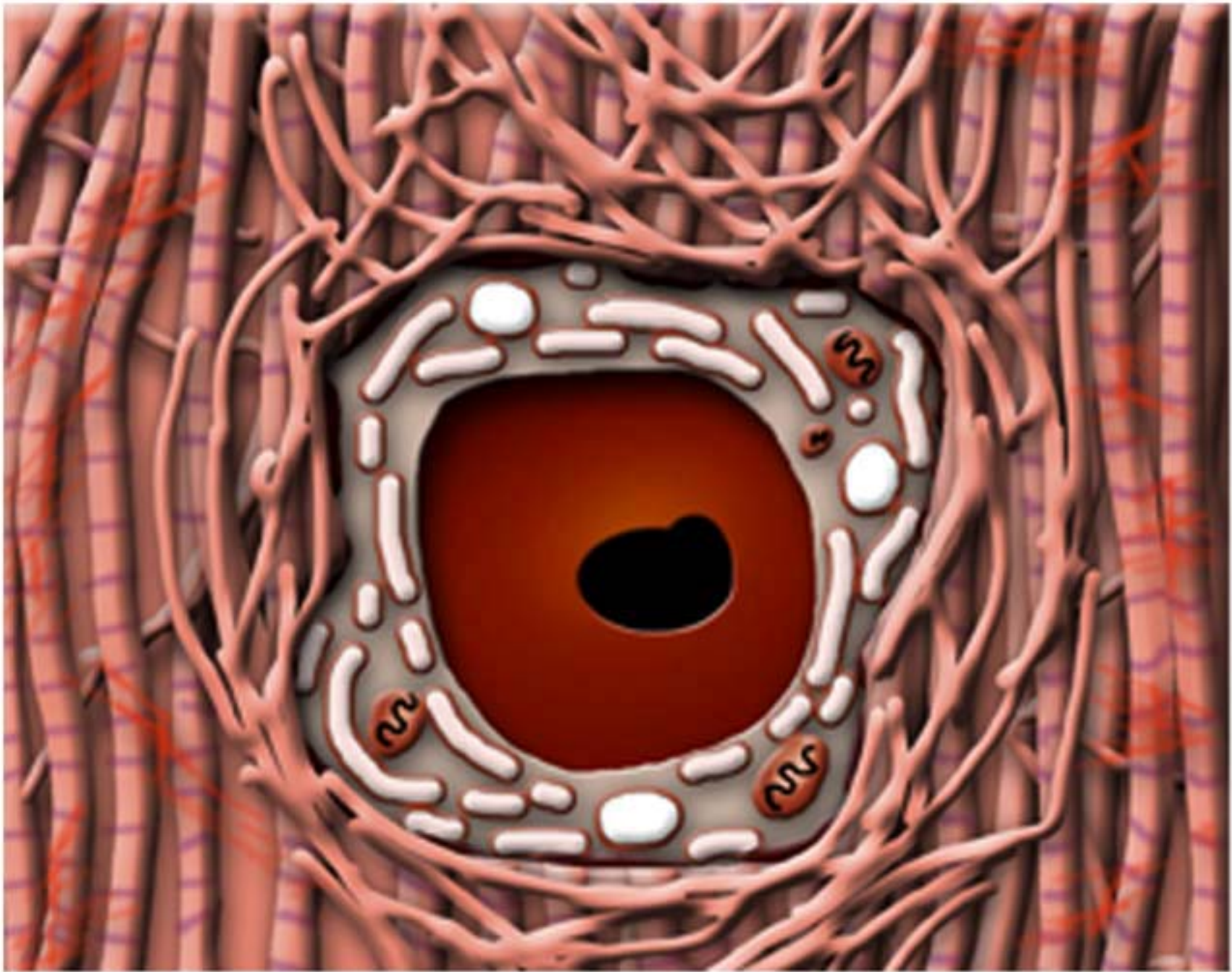
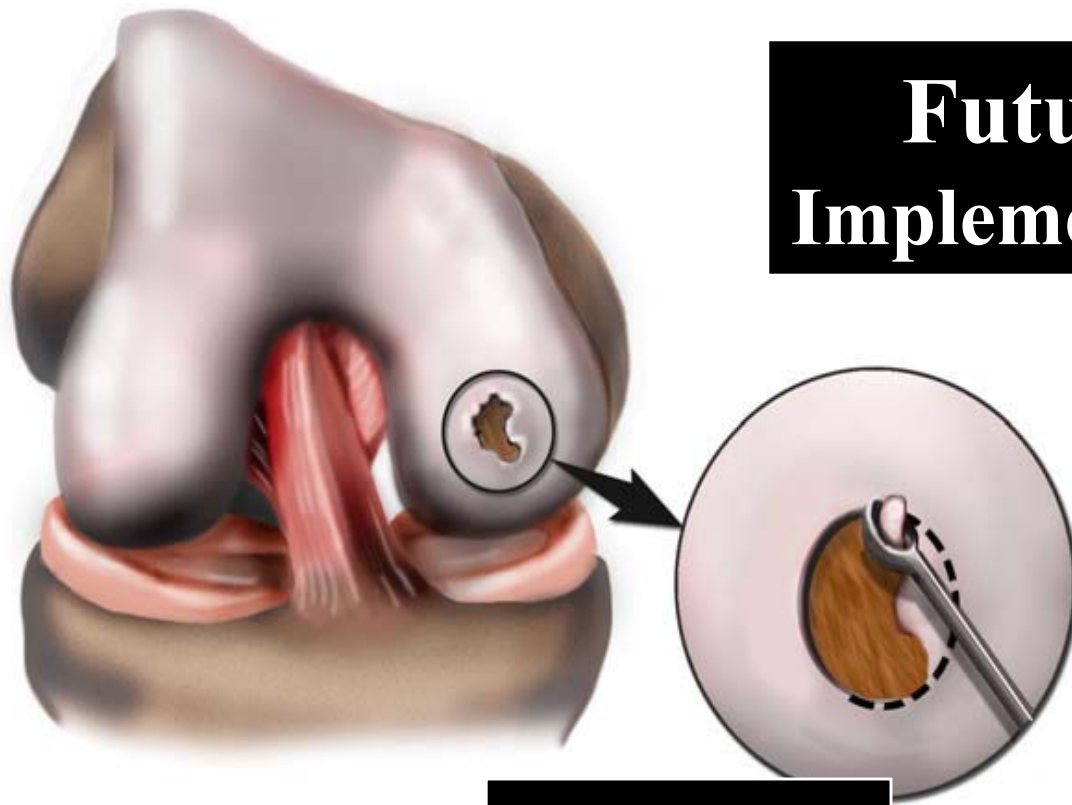

Figure by MIT OCW.

Future Clinical Practice Implementing Tissue Engineering



Microfracture

Implantation of a cell-seeded matrix

Photo removed for copyright reasons.

Figure by MIT OCW.

Diagram removed for copyright reasons.

Stem cells from bone marrow infiltrate the defect

Implantation of the matrix alone, or supplemented with growth factors or genes for the GFs

ELEMENTS FOR TISSUE ENGINEERING

Tissue Engineering Triad*

- CELLS
- MATRIX (INSOLUBLE REGULATOR)
 - Porous, absorbable biomaterials
- SOLUBLE REGULATORS
 - Cytokines (Growth Factors)

Environmental Factors

- Mechanical loading

* Used individually or in combination, but probably always best with a matrix (*i.e.*, with a biomaterial)

ARTICULAR CARTILAGE

Limits to Regeneration

- **Avascular (and aneural)**
- **Relatively low cell density**
- **Cells of low mitotic activity**
- **Cells cannot freely migrate**

Image removed for copyright reasons.

TISSUE ENGINEERING

Cells

- **Autologous, allogeneic, or xenogeneic**
- **Differentiated cell of the same tissue type or another tissue type, or stem cell**

Autologous Chondrocyte Implantation

Diagram removed for
copyright reasons.

**This process has been commercialized
by Genzyme (for USD\$11,500).**

M Brittberg, *et al.*, NEJM 33:889 (1994)

Canine Study

Autologous Chondrocyte Implantation

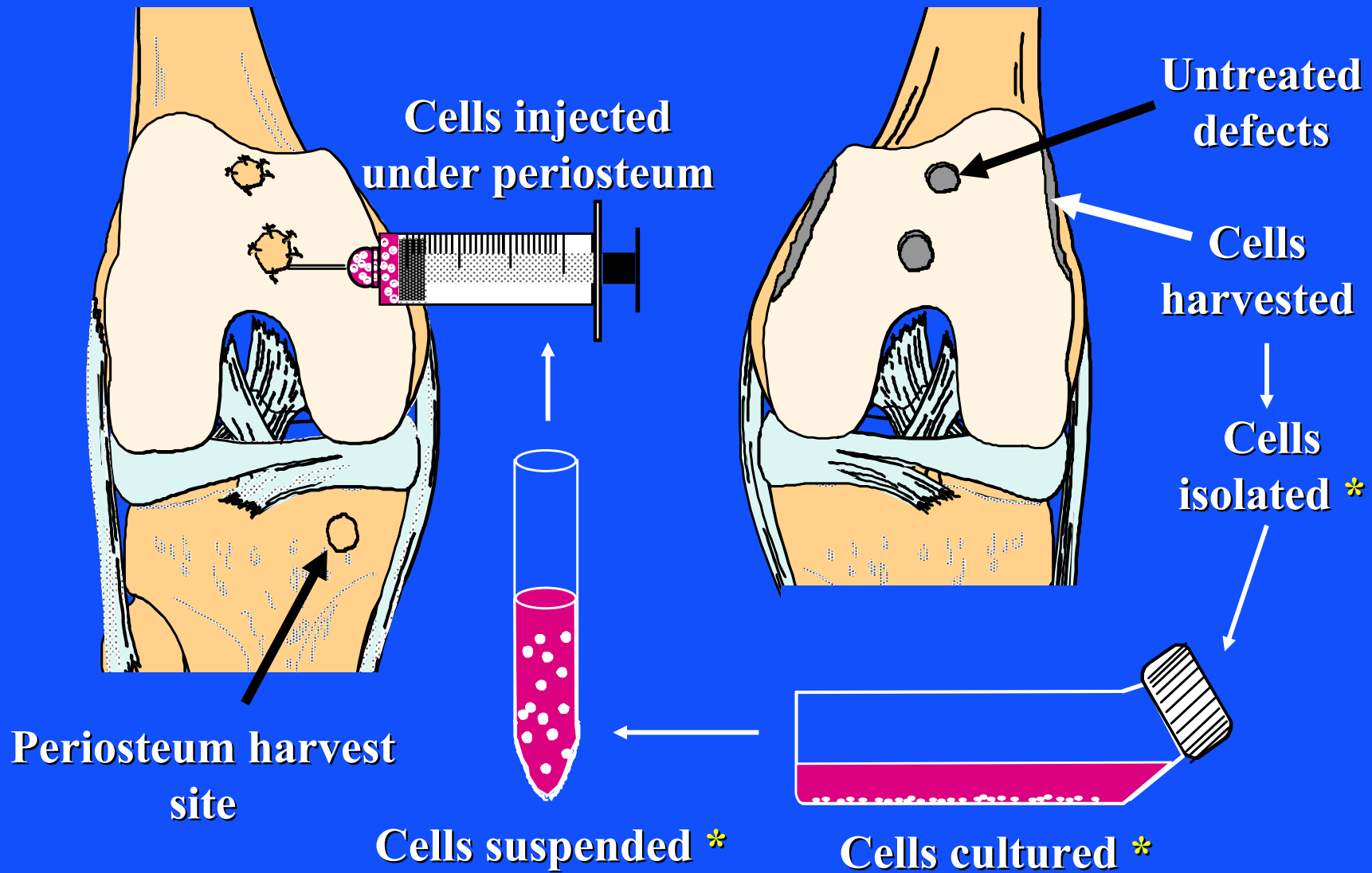

* by Genzyme Biosurgery

AUTOLOGOUS CHONDROCYTE-SEEDED COLLAGEN MATRIX

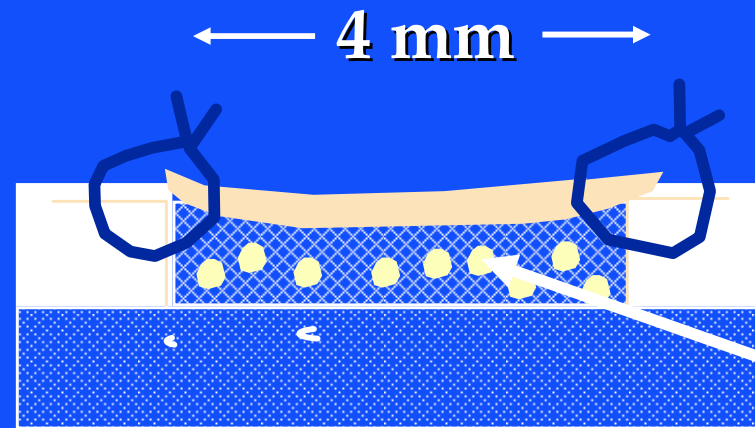

Chondrocyte-seeded
type II collagen
implant*

* Cells seeded into the matrix 24 hours*
and 4 weeks prior to implantation

* HA Breinan, *et al.* J. Orthop. Res. 2000;18:781-789
and C.R. Lee, *et al.* J. Orthop. Res. 2003;21:272-281

Seeding of Collagen Matrices with CAC

Diagram removed for
copyright reasons.

Collagen discs
9 mm diam x 3 mm thick

CR Lee, *et al*, *Biomater.* 2001;22:3145.

Chondral defect immediately postoperative. Arrow shows perforation of calcified cartilage and subchondral bone (SCB)

Photo removed
for copyright
reasons.

Defects treated by autologous chondrocyte implantation, 6 months postoperative

Photo removed
for copyright
reasons.

**H. Breinan, *et al.*
J. Orthop. Res. 2001;19:282-292**

AUTOLOGOUS CHONDROCYTE IMPLANTATION

1.5 mo. Fibrous tissue

Photo removed
for copyright
reasons.

**3 mo. Hyaline cartilage (some
articular cartilage),
fibrocartilage, and fibrous tissue**

Photo removed
for copyright
reasons.

6 mo. Art. cart. and fibrocartilage

12 mo. Degraded tissue

**Tissue that formed after 3 and 6
months did not function longer term.
Is the problem a lack of fill or the
tissue types comprising the material?**

Summary of Results: Canine Model

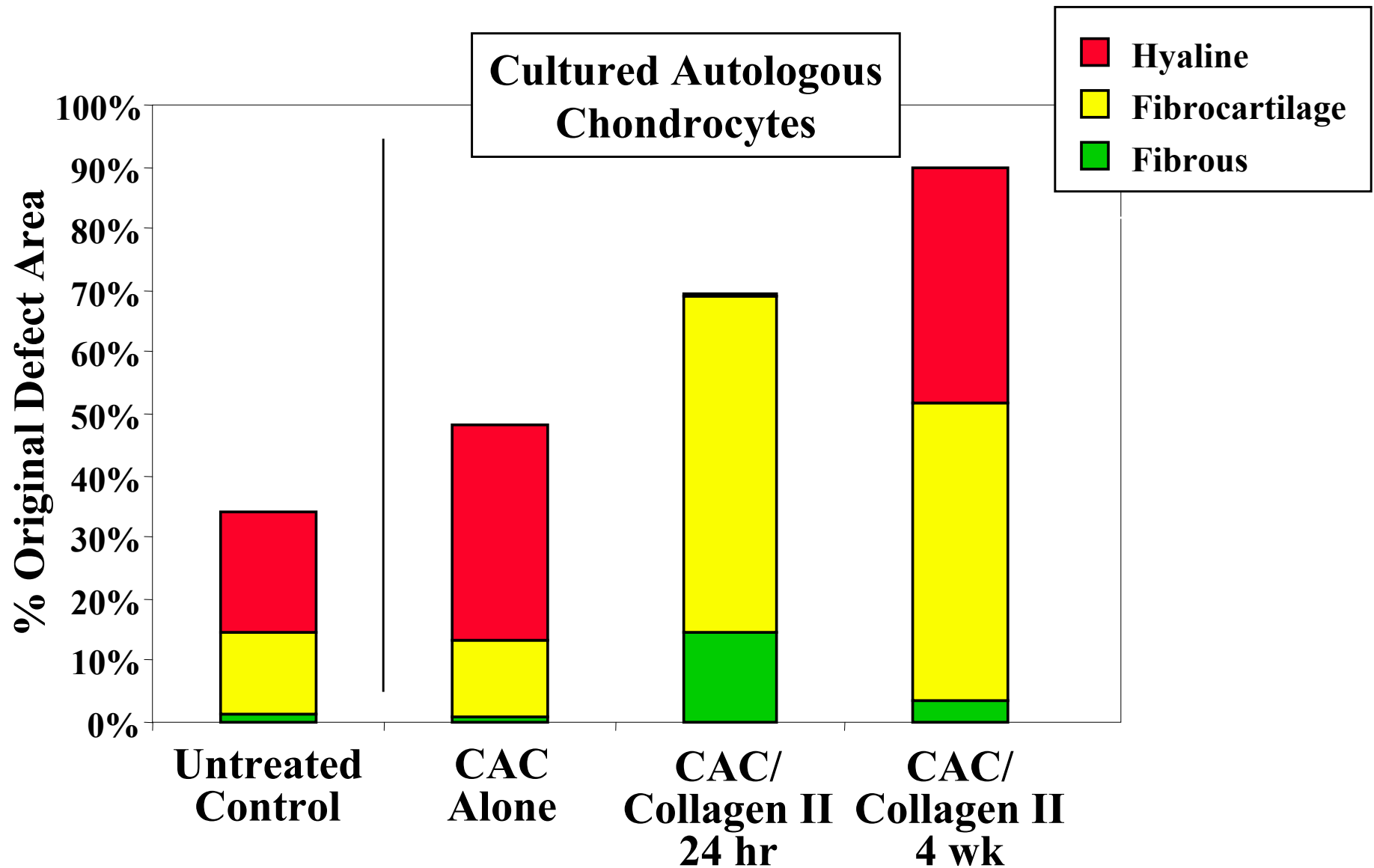

15 Wks Post-op, Mean, n=6

HA Breinan, *et al.* J. Orthop. Res. 2000;18:781-789
and C.R. Lee, *et al.* J. Orthop. Res. 2003;21:272-281

Future Clinical Practice Implementing Tissue Engineering

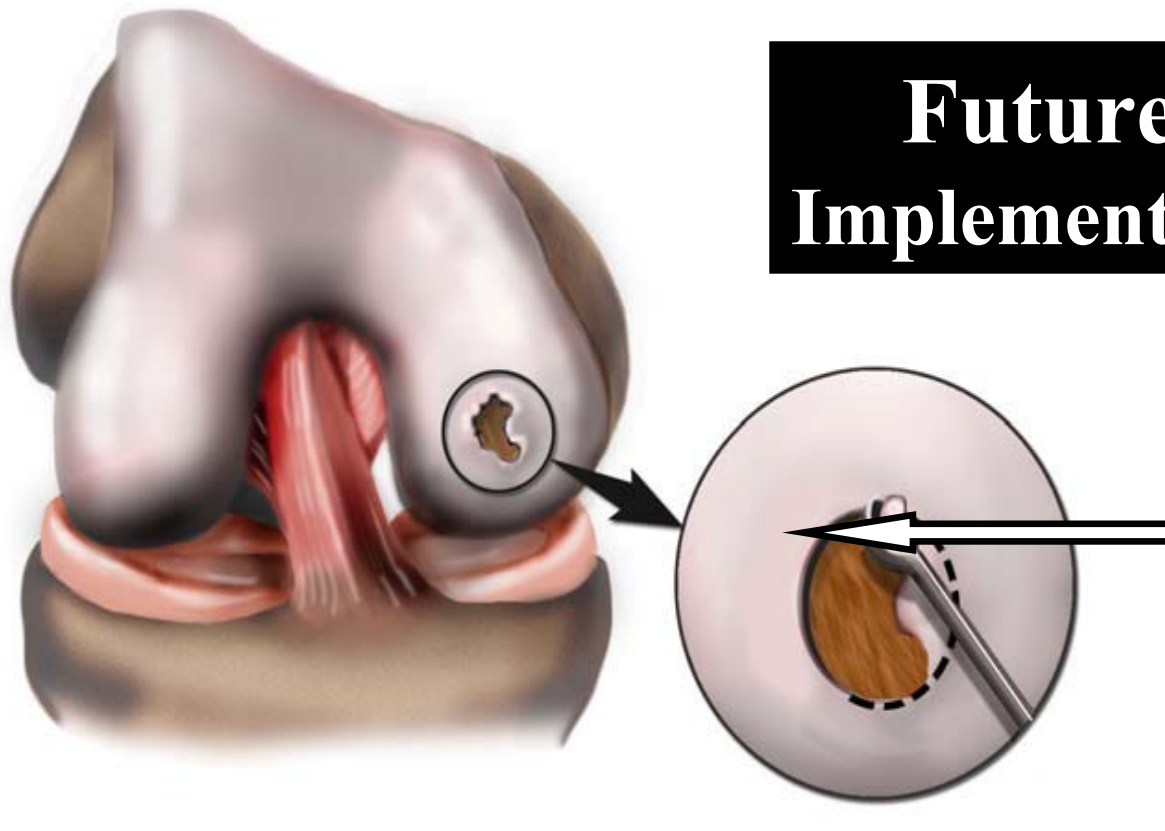

Implantation of a **cell-seeded matrix**

Photo removed for copyright reasons.

Figure by MIT OCW.

Diagram removed for copyright reasons.

Implantation of the **matrix alone**,
(or supplemented with growth factors or genes for the GFs)

“Microfracture”:
Stem cells from bone marrow infiltrate the defect

CANINE MICROFRACTURE STUDY TREATMENT GROUPS

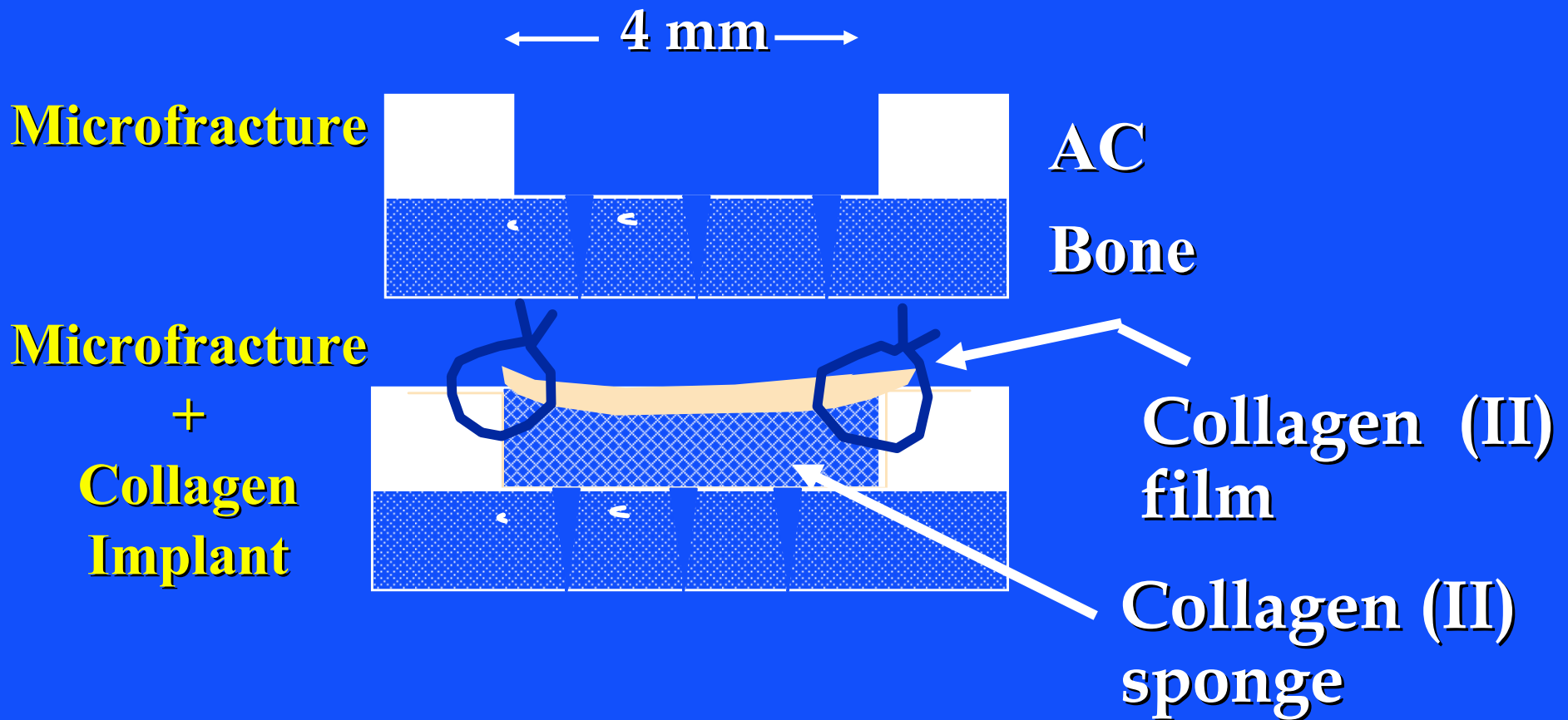

* HA Breinan, *et al.* J . Orthop. Res. 2000;18:781-789

Summary of Results: Canine Model

- Hyaline
- Fibrocartilage
- Fibrous

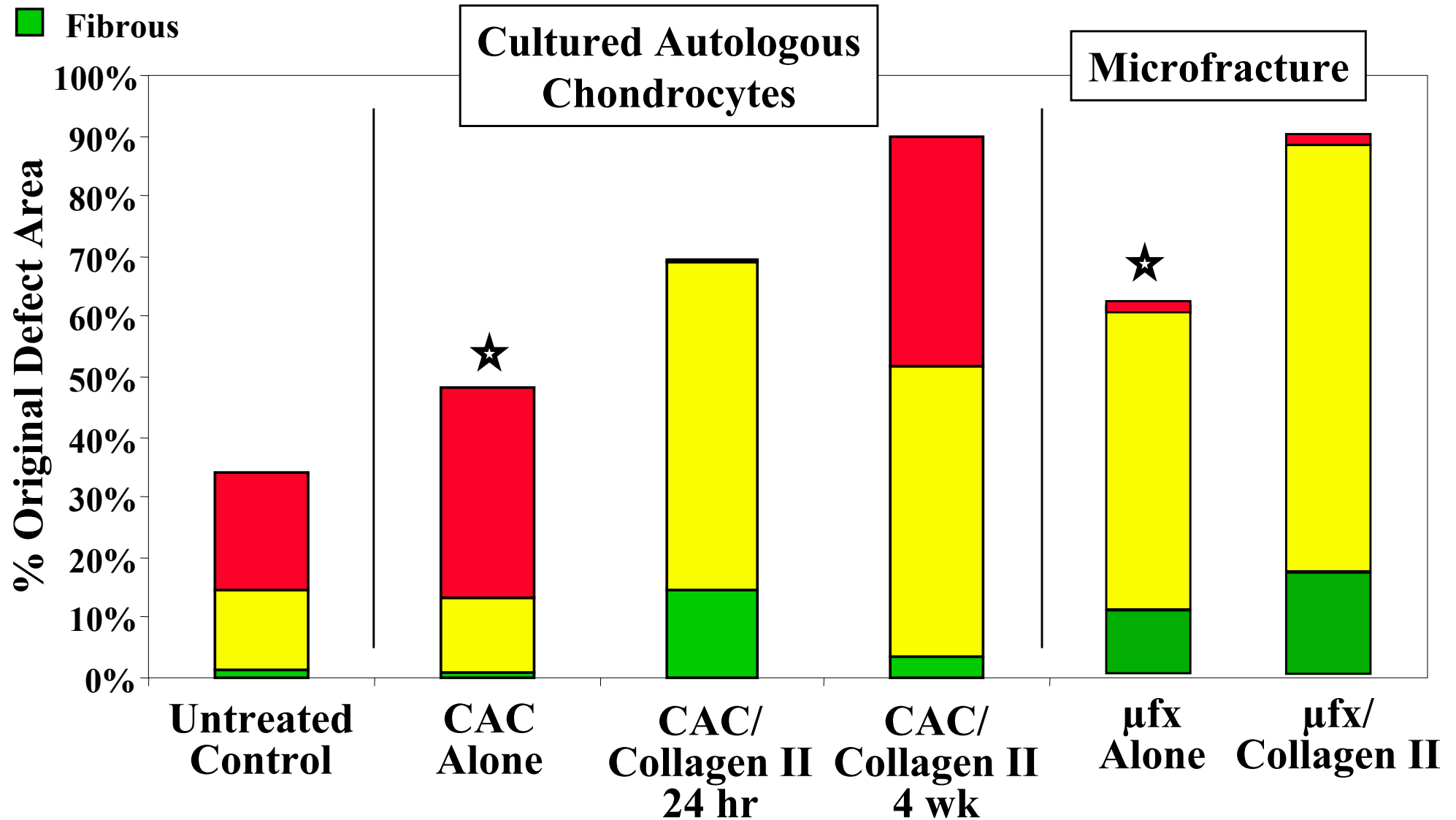

15 Wks Post-op, Mean, n=6

★ Procedures currently used

Articular Cartilage

Approaches for osteochondral defects?

Diagrams removed for copyright reasons.

- **One scaffold for both cartilage and bone or two different scaffolds?**
- **Separate layer for calcified cartilage?**
- **Scaffold(s) alone or cell-seeded?**
- **One cell type for both cartilage and bone?**
- **Two cell types?**
 - **Seeded as a mixture?**
 - **Separate cell types in each scaffold?**